

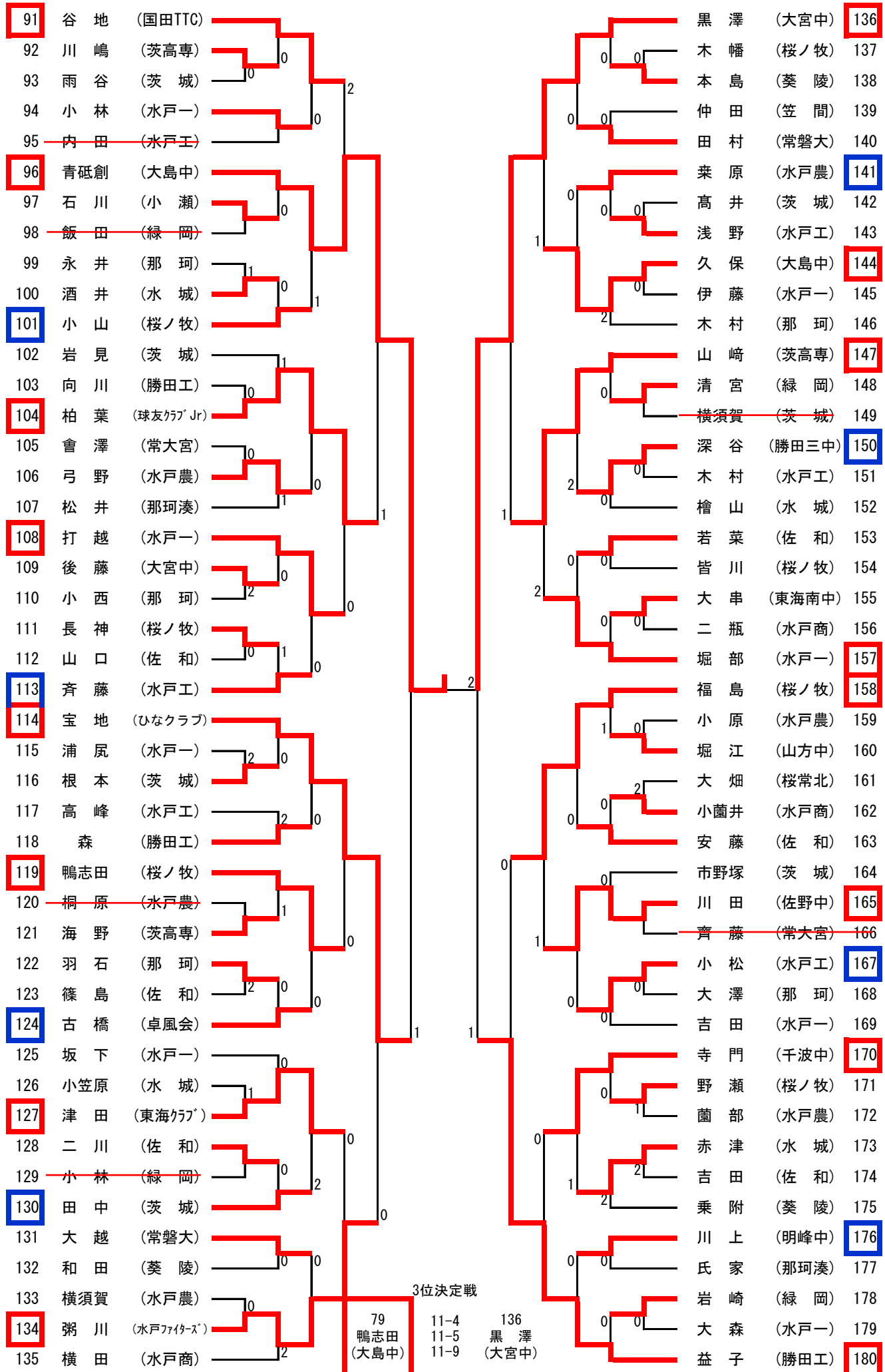

男子シングルス (2)



推薦: 堀内(大成女), 金澤(水戸農)

二次免除: 大橋(田彦中), 田尻(Over Limit), 江幡(那珂四中), 小泉(那珂Vジュニア), 青木・松岡(水戸葵ジュニア), 栗原(水戸ファイターズ)

女子シングルス

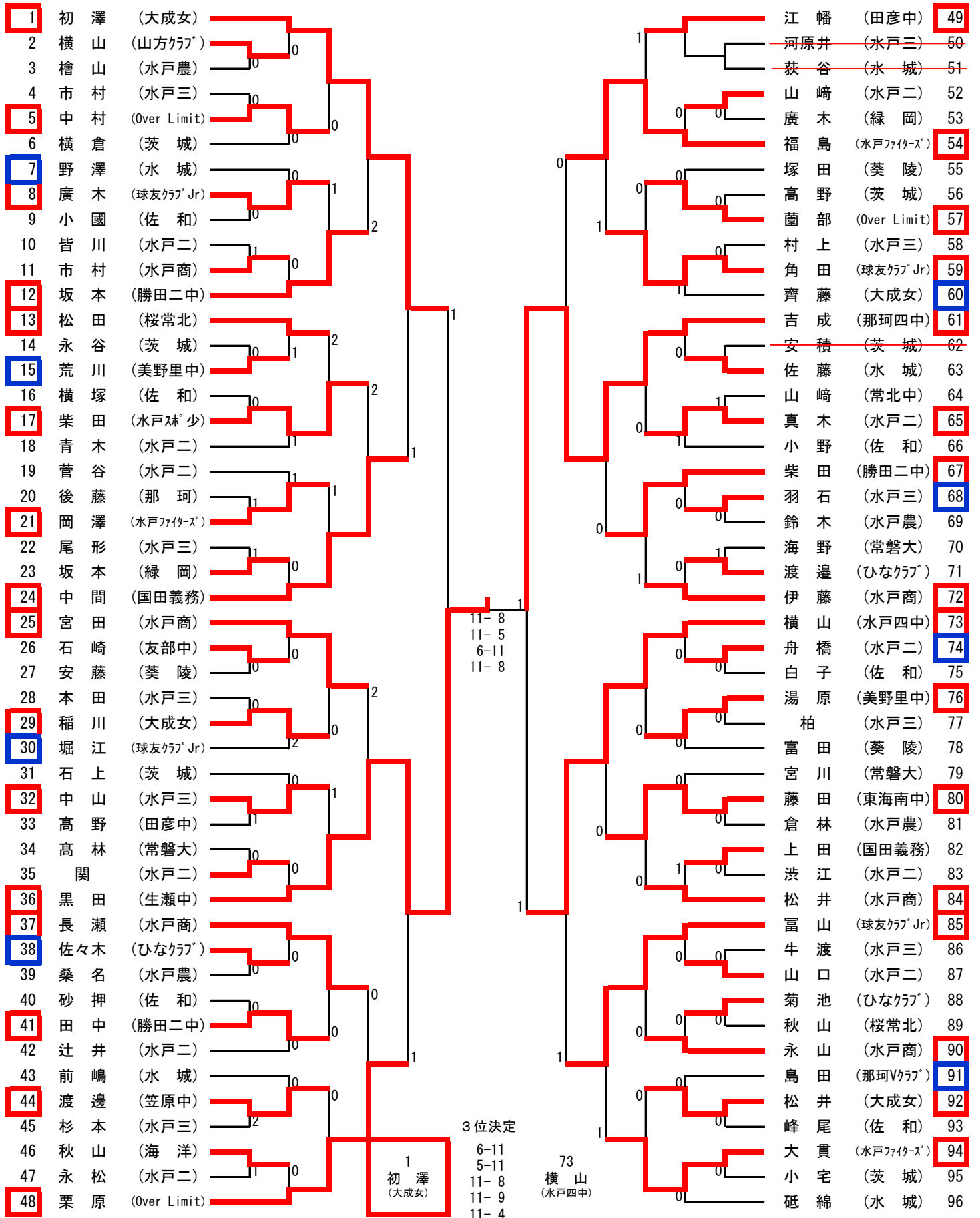

男子ダブルス

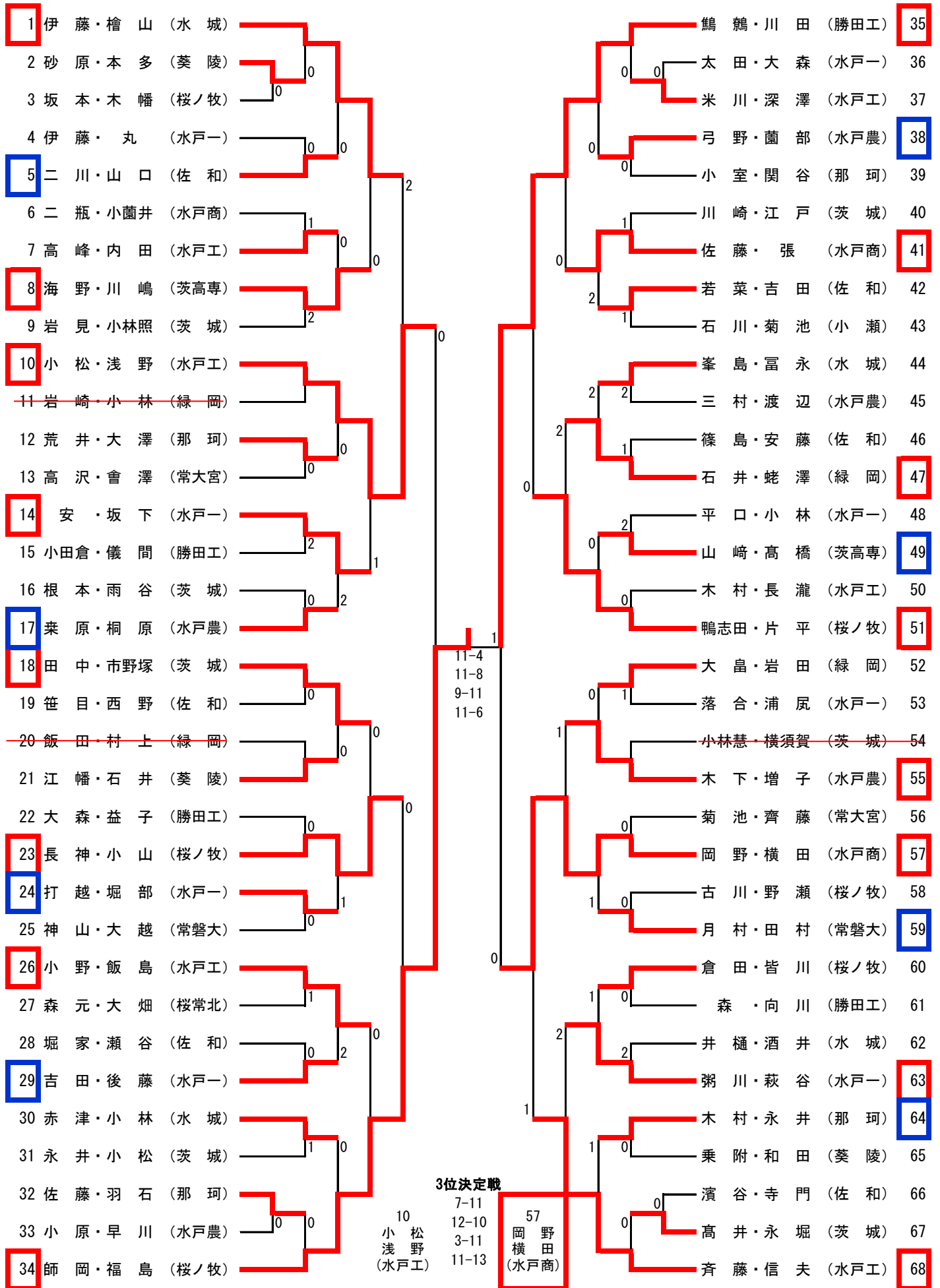

女子ダブルス

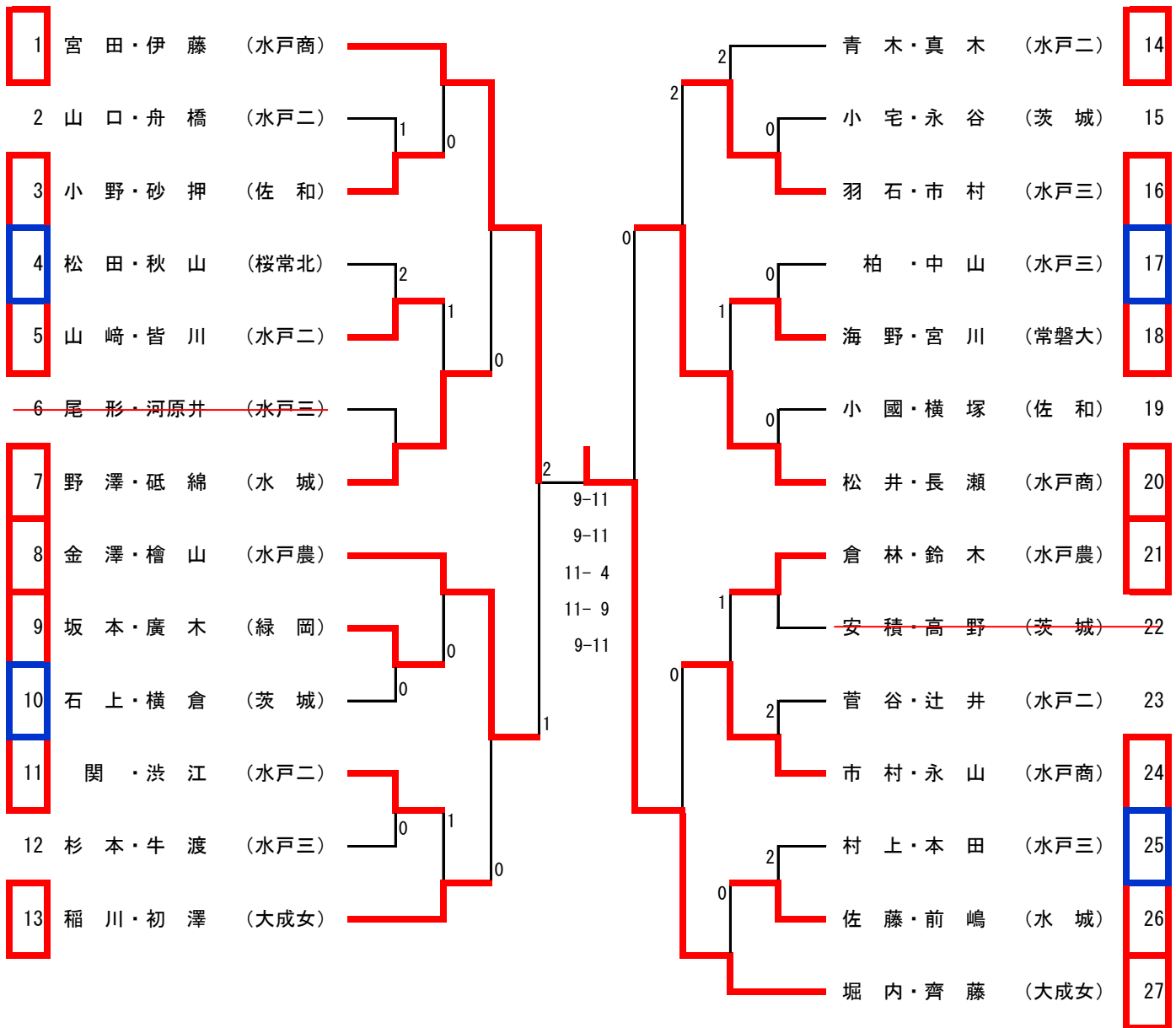









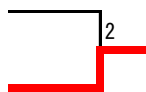
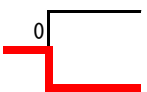

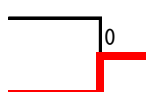
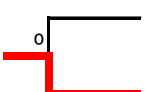

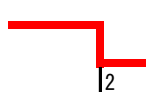
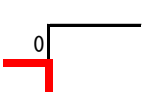
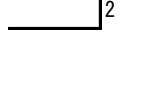

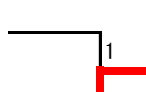

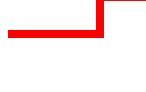
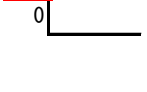
3位決定

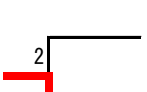
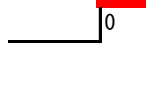

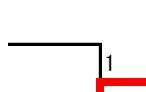
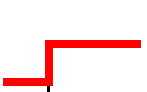
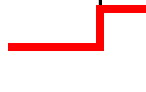
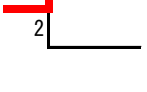

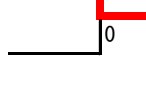
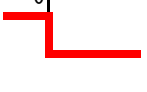
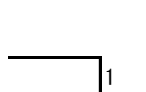
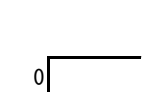





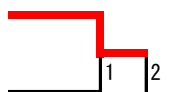
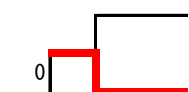

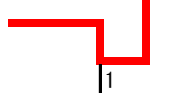
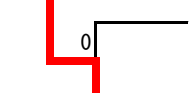
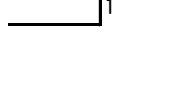
8	11-6	20
金澤	9-11	松井
檜山	11-9	長瀬
(水戸農)	7-11	(水戸商)
	10-12	

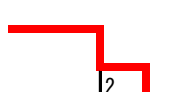
代表決定戦

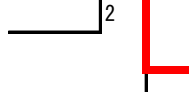
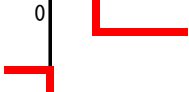
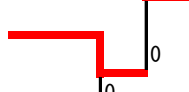
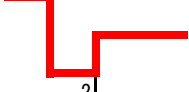
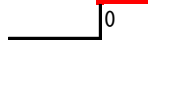
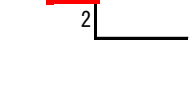
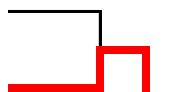
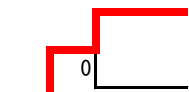
男子シングルス

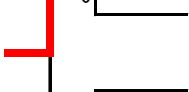
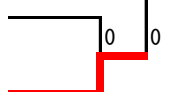
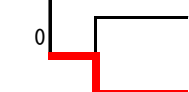
4	蛭澤	(緑岡)			小林	(水戸一)	94
8	月村	(常磐大)			小山	(桜ノ牧)	101
16	関谷	(那珂)			弓野	(水戸農)	106
18	小田倉	(勝田工)			斉藤	(水戸工)	113
28	粥川	(水戸一)			森	(勝田工)	118
34	小野	(水戸工)			古橋	(卓風会)	124
39	太田	(水戸一)			田中	(茨城)	130
41	小此木	(佐野中)			大越	(常磐大)	131
49	佐藤	(那珂)			田村	(常磐大)	140
52	笹目	(佐和)			栗原	(水戸農)	141
58	萩谷	(水戸一)			深谷	(勝田三中)	150
63	木下	(水戸農)			若菜	(佐和)	153
68	荒井	(那珂)			安藤	(佐和)	163
74	増子	(水戸農)			小松	(水戸工)	167
84	三村	(水戸農)			赤津	(水城)	173
87	石井	(緑岡)			川上	(明峰中)	176

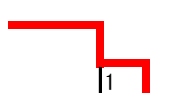
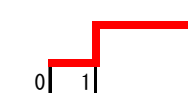
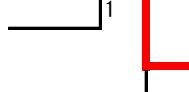
女子シングルス

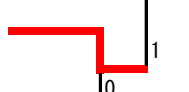
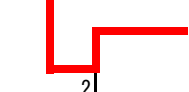
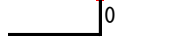
2	横山	(山方クラブ)			山崎	(水戸二)	52
6	横倉	(茨城)			塚田	(葵陵)	55
7	野澤	(水城)			齊藤	(大成女)	60
11	市村	(水戸商)			佐藤	(水城)	63
15	荒川	(美野里中)			小野	(佐和)	66
18	青木	(水戸二)			羽石	(水戸三)	68
19	菅谷	(水戸二)			渡邊	(ひなクラブ)	71
23	坂本	(緑岡)			舟橋	(水戸二)	74
<del>26</del>	<del>石崎</del>	<del>(友部中)</del>			富田	(葵陵)	78
30	堀江	(球友クラブ Jr)			<del>宮川</del>	<del>(常磐大)</del>	<del>79</del>
31	石上	(茨城)			上田	(国田義務)	82
35	関	(水戸二)			山口	(水戸二)	87
38	佐々木	(ひなクラブ)			菊池	(ひなクラブ)	88
42	辻井	(水戸二)			島田	(那珂Vクラブ)	91
43	前嶋	(水城)			砥綿	(水城)	96
46	秋山	(海洋)					

代表決定戦

男子ダブルス

5	二川・山口	(佐和)		0	弓野・菌部	(水戸農)	38
7	高峰・内田	(水戸工)			若菜・吉田	(佐和)	42
12	荒井・大澤	(那珂)			峯島・富永	(水城)	44
17	栞原・桐原	(水戸農)			山崎・高橋	(茨高専)	49
21	江幡・石井	(葵陵)			大畠・岩田	(緑岡)	52
24	打越・堀部	(水戸一)			月村・田村	(常磐大)	59
29	吉田・後藤	(水戸一)			倉田・皆川	(桜ノ牧)	60
30	赤津・小林	(水城)			木村・永井	(那珂)	64

代表決定戦  
 女子ダブルス

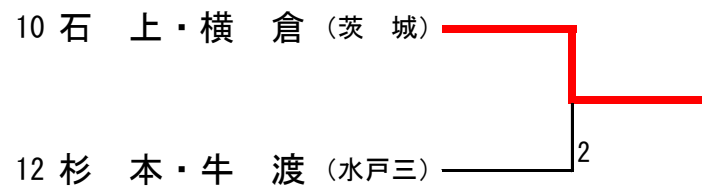
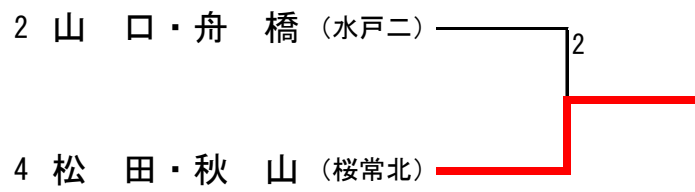

	小宅永谷	柏中山	小國横塚	勝敗	順位
15 小宅永谷 (茨城)		0	0	0-2	3
17 柏中山 (水戸三)	11-5 11-3 11-3		11-6 11-8 11-8	2-0	1
19 小國横塚 (佐和)	11-4 11-5 11-6	0		1-1	2

